



ColumbusJACK/Regent

"The Strength of Experience"

PRODUCT DATA SHEET

FIXED HEIGHT TRIPOD JACK

Model 20152-35, 20 Ton Capacity

Standard Features

- ◆ Constructed for ease of assembly, operation and maintenance
- ◆ Manifold Hydraulics - includes Manual & Air Powered Pumping Units, Dual Reading Pressure Gauge Assembly (Reading in Tons/PSI) and External Relief Valve
- ◆ Steel Reservoir with sight gauge. Also includes a hydraulic isolation valve.
- ◆ Mechanical Lock Nut
- ◆ Operator Platform/Ladder Assembly
- ◆ Tow Bar Assembly
- ◆ Spring Loaded Swivel Casters with Caster Locks (Maximum towing speed 5 MPH)
- ◆ Adjustable Leveling Footpads with Bubble Level
- ◆ Protective Cylinder Rain Cover
- ◆ Skydrol Resistant Yellow Paint or to customer specifications

Documentation

- ◆ Operation and Maintenance Manual
- ◆ Certificate of Conformance
- ◆ Load Test Reports
- ◆ Factory New - 36 Month Written Warranty

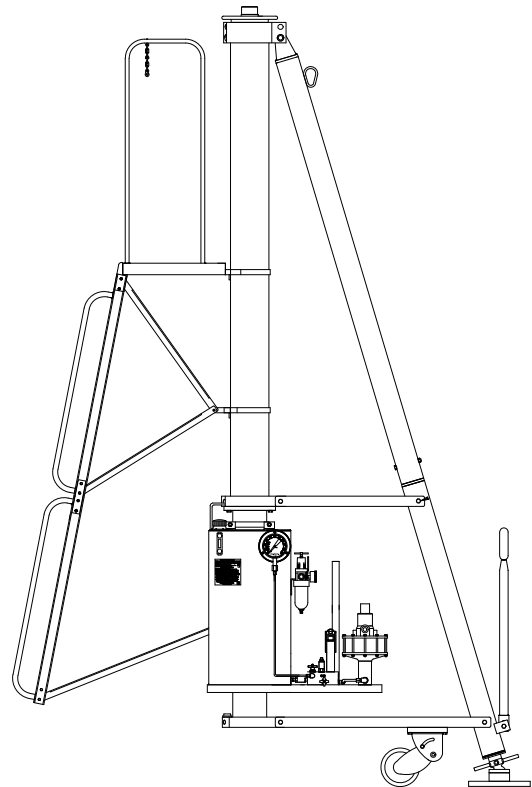

Our Fixed Height Tripod Jacks are used on and for specific aircraft jacking applications during normal aircraft maintenance checks. Our tripod jacks are designed and built to withstand harsh environmental conditions, rugged use and to provide many years of continuous service.

FIXED HEIGHT TRIPOD JACK SPECIFICATIONS							
VERTICAL CAPACITY (Tons/m tonnes)	MINIMUM HEIGHT (Inches/mm)	HYDRAULIC LIFT (Inches/mm)	SCREW EXTENSION (Inches/mm)	MAXIMUM EXTENDED HEIGHT (Inches/mm)	CRATED WEIGHT (Est.) (Lbs/kg)	CRATE DIMENSIONS (Est. - L x W x H) (Inches/mm)	CU FT CRATED (Est.) (Cu ft/cu m)
20.0	152.0	85.0	12.0	249.0	2,700	40 x 36 x 40 110 x 36 x 40 105 x 36 x 40	212
18.2	3,861	2,159	305	6,325	1,225	1,016 x 914 x 1,016 2,794 x 914 x 1,016 2,667 x 914 x 1,016	6.0



Columbus JACK/Regent

"The Strength of Experience"

ISO 9001:2008

FIXED HEIGHT TRIPOD JACK

Model 20152-35, 20 Ton Capacity

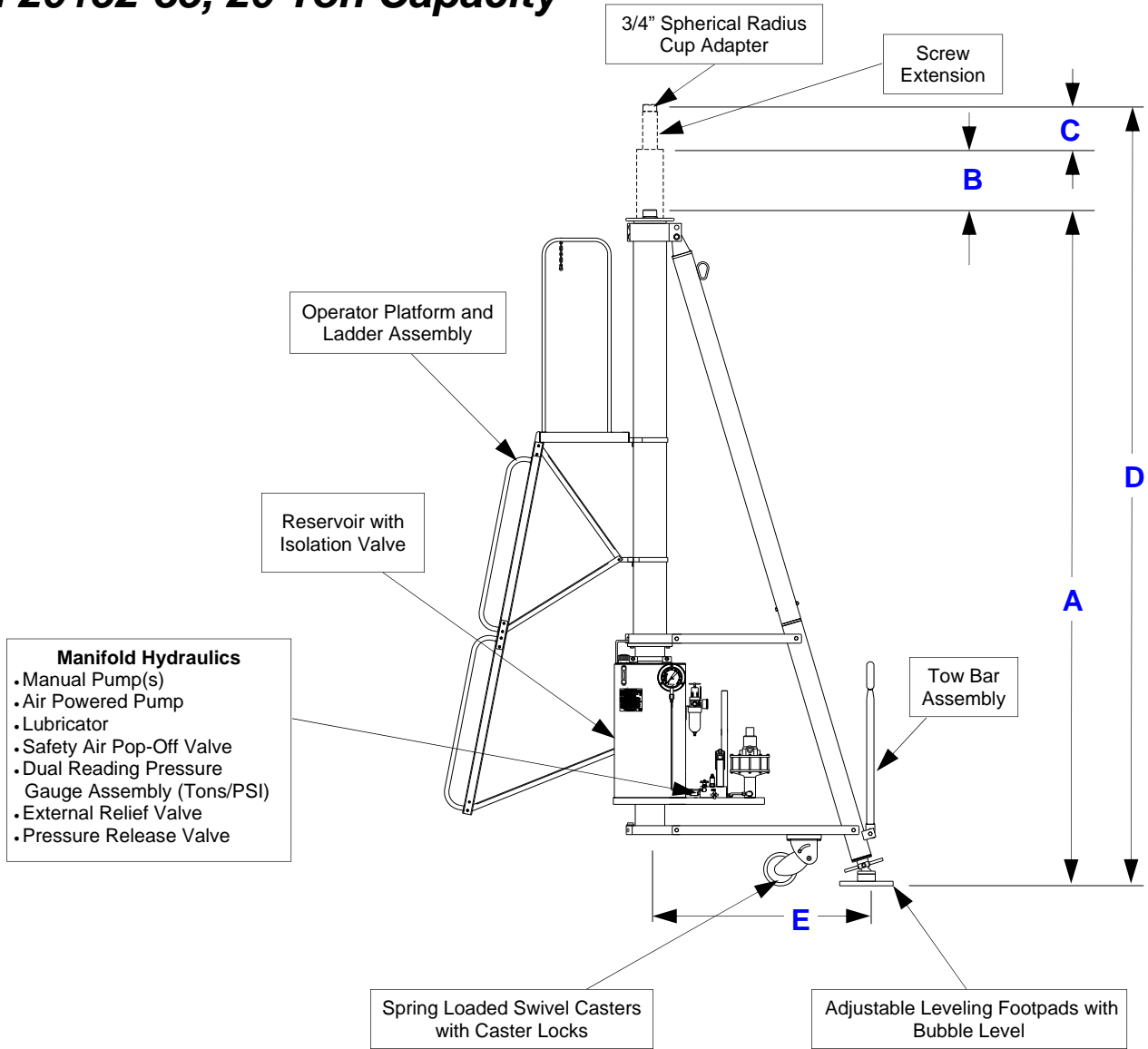

FIXED HEIGHT TRIPOD JACK SPECIFICATIONS					
	A	B	C	D	E
VERTICAL CAPACITY (Tons/m tonnes)	MINIMUM CLOSED HEIGHT (Inches/mm)	HYDRAULIC LIFT (Inches/mm)	SCREW EXTENSION (Inches/mm)	MAXIMUM EXTENDED HEIGHT (Inches/mm)	TRIPOD RADIUS (Inches/mm)
20.0	152.0	85.0	12.0	249.0	48.5
18.2	3,861	2,159	305	6,325	1,232